

MDS Medical AC-DC Open Frame

400Watt / MDS-400AUS□ B

400AUS



Highlights & Features

- Safety Approvals to IEC 60601-1 3rd ed. & IEC 62368-1
- Risk management report available
- Low touch current (<0.1mA Normal & ,0.3mA single fault)
- Over-Voltage/Load/Temperature & Short Circuit protections
- 2 Million Hours MTBF
- 2 x MOPP (means of patient protection)
- 3 years warranty

Safety Standards



CB Certified for worldwide use

Model Number: MDS-400AUS□ B
Unit Weight: 910 grams (32.1 ounces)
Dimensions (W x L x H): 97.0 x 198.0 x 41.5 mm
 3.82 x 7.80 x 1.63 in

General Description

The MDS series of embedded power supply comes with universal AC input at 90Vac to 264Vac. Other features include low earth leakage, risk management report available and the electric shock protection comply with 2 x MOPP. The MDS series is certified for EMC standards according to EN 55011 for industrial, scientific and medical (ISM) radio-frequency equipment and EN 55032 for Information Technology Equipment (ITE) radio-frequency equipment.

The MDS series come with both medical and ITE safety approvals including UL/cUL/CCC/CE and CB certification and are fully compliant with RoHS Directive for environmental protection.

Model Information

Medical AC-DC Open Frame

Model Number	Input Voltage Range	Output Voltage	Conversion Current Output	Forced Air Current Output
MDS-400AUS19 B	90-264Vac	19Vdc	15.8A	21.1A*
MDS-400AUS24 B	90-264Vac	24Vdc	12.5A	16.67A*
MDS-400AUS30 B	90-264Vac	30Vdc	11.67A	13.3A*

* With 200LFM force air

Model Numbering

MDS <small>Delta Medical power Supply</small>	-	400 <small>Max wattage in the product series. Maybe lower at some voltage. 400 → 400W</small>	AUS <small>Family Code</small>	□ <small>Output Voltage Single Output: 19 for 19V 24 for 24V 30 for 30V</small>	B
---	---	---	--	--	----------

MDS Medical AC-DC Open Frame

400Watt / MDS-400AUS□ B

Specifications

Input Ratings / Characteristics

Model Number	MDS-400AUS19 B	MDS-400AUS24 B	MDS-400AUS30 B
Nominal Input Voltage	100-240Vac		
Input Voltage Range	90-264Vac		
Nominal Input Frequency	50-60Hz		
Input Frequency Range	47-63Hz		
Input Current (max)	5.5A @ 90Vac, 2.7A @ 264Vac		
Efficiency (typ.)	91.38%, Reference Fig.1-1	91.94%, Reference Fig.1-2	92.51%, Reference Fig.1-3
Standby Power (max)	1.2W		
Inrush Current (typ.)	60A @ 115Vac, 60A @ 230Vac		
Earth Leakage Current (max)	0.1mA @ 240Vac NC ¹⁾ , 0.3mA @ 264Vac SFC ²⁾		

1) NC: normal condition

2) SFC: single fault condition

MDS-400AUS19 B

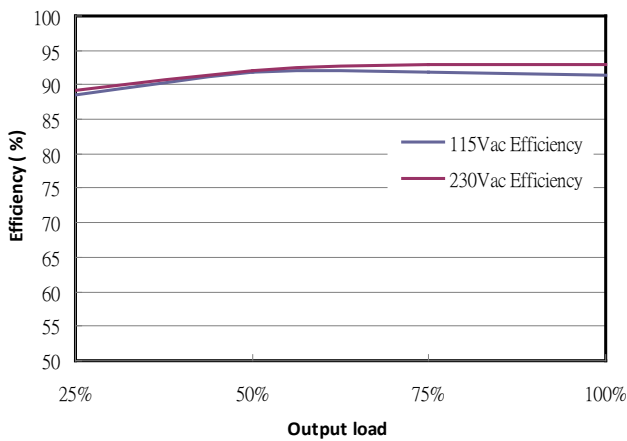

Fig.1-1 MDS-400AUS19 B Efficiency versus output load

MDS-400AUS24 B

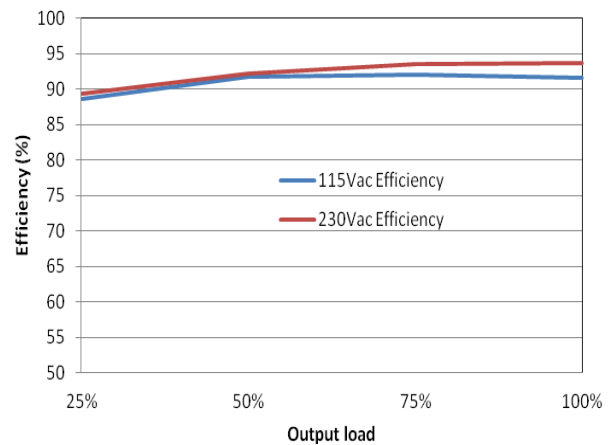

Fig.1-2 MDS-400AUS24 B Efficiency versus output load

MDS-400AUS30 B

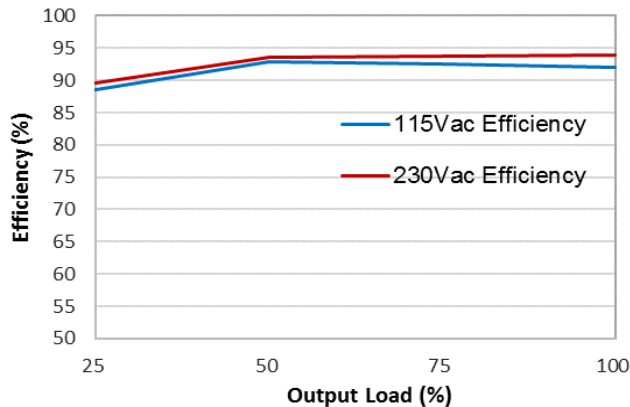

Fig.1-3 MDS-400AUS30 B Efficiency versus output load

MDS Medical AC-DC Open Frame

400Watt / MDS-400AUS□ B

Output Ratings / Characteristics

Model Number	MDS-400AUS19 B	MDS-400AUS24 B	MDS-400AUS30 B
Nominal Output Voltage	19Vdc	24Vdc	30Vdc
Output Voltage Tolerance	± 2%		
Output Current	21.1A with 200LFM force air, 15.8A for convection	16.67A with 200LFM force air, 12.5A for convection	13.33A with 200LFM force air, 11.67A for convection
Output Power	400W with 200LFM force air, 300W for convection	400W with 200LFM force air, 300W for convection	400W with 200LFM force air, 350W for convection
Line Regulation (max)	±0.5%	±0.5%	±1%
Fan Supply	12V 0.25A	12V 0.25A	N/A
Remote Sense	Compensates for up to 500mV voltage drop		
Ripple & Noise (typ.)*	±1% pk-pk @ Full load	±1% pk-pk @ Full load	±1.5% pk-pk @ Full load
Hold-up Time (min)	12ms @ 115Vac		

*Ripple & Noise is measured with AC coupling mode, and in parallel to end with 0.47uF ceramic capacitor & 10uF electrolytic capacitor.

Ripple & Noise measurement circuit

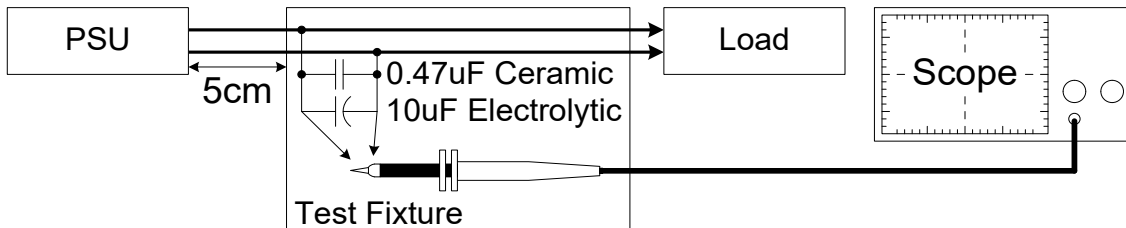

MDS Medical AC-DC Open Frame

400Watt / MDS-400AUS□ B

Mechanical

Model Number		MDS-400AUS19 B	MDS-400AUS24 B	MDS-400AUS30 B
Case Chassis		AL1100F (with black electro coating)		
Case Cover		NA		
Dimensions (W x Lx H)		97.0x198.0x41.5 mm (3.82x7.80x1.63 in)		
Unit Weight		910 grams (32.1 ounces)		
Power de-rating curve		See Fig. 3-1 & Fig. 3-2 (400W with forced air flow)		
Terminal	Input	DECA: T33-BM1103A301		
	Output	DECA: T33-BM1104A301		
DC Fan	Output	JWT: A2508WV0-2P	JWT: A2508WV0-2P	NA

Environment

Surrounding Air Temperature	Operating	-10°C to +70°C		
	Storage	-40°C to +85°C		
Power De-rating	-10°C to +50°C 100% load 50°C to 70°C with load de-rate power			
Operating Humidity	5-95% RH (Non-Condensing)			
Storage Humidity	5-95% RH (Non-Condensing)			
Operating Altitude		Up to 3,000 meters (up to 9,842 feet or 106-70kPa)	Up to 3,000 meters (up to 9,842 feet or 106-70kPa)	Up to 5,000 meters (up to 16,404 feet or 106-54kPa)
Shock Test	Non-Operating	50G, 11ms, 3 shocks for each direction		
Vibration	Non-Operating	5-500Hz, 2.09Grms, 20 minute for each three axis		

Protections

Overtoltage (max)	150%, Latch Mode			
Over load / Over current (max)	130% of rated load current, Hiccup Mode, (Non-Latching, Auto-Recovery)			
Over Temperature	Hiccup Mode	Latch Mode	Hiccup Mode	
Short Circuit	Hiccup Mode, (Non-Latching, Auto-Recovery)			
Protection Against Shock	Class I with PE* connection			

*PE: Protective Earth

Reliability Data

MTBF	2 Million Hrs based on Telecordia SR-332	2 Million Hrs based on Telecordia SR-332	500K Hours based on Telecordia SR-332
------	---	---	--

MDS Medical AC-DC Open Frame

400Watt / MDS-400AUS□ B

Safety Standards / Directives

Medical Safety	All models	IEC60601-1 3 rd and 3.1 rd edition CB report IEC60601-1 edition 3.1 rd (2012), EN60601-1 (2006) + A11 + A1 + A12, CAN/CSA-C22.2 NO. 60601-1:14, ANSI/AAMI ES60601-1:2005/(R)2012
ITE	All models	IEC60950-1 (Ed.2,2005) , IEC62368-1, GB4943.1-2011, GB9254-2008, GB17625.1-2003 UL 60950-1 +CSA C22.2 No. 60950-1-07 UL 62368-1 +CSA C22.2 No. 62368-1-14
CE		MDD Directive 93/42/EEC
Galvanic Isolation	Input to Output	4000 Vac
	Input to Ground	1500 Vac
	Output to Ground	500 Vac

EMC (Compliant with IEC 60601-1-2 4th Ed. Requirements)

EMC / Emissions		EN55011/EN55032, FCC Title 47:Class B
Harmonic Current	IEC61000-3-2	Meet Class D limit
Immunity to		
Voltage Flicker	IEC61000-3-3	
Electrostatic Discharge	IEC61000-4-2	Level 4 Criteria A ¹⁾ Air Discharge: 15kV Contact Discharge: 8kV
Radiated Field	IEC61000-4-3	Criteria A ¹⁾ 80MHz-2700MHz, 10V/m AM modulation 385MHz-5785MHz, 28V/m Pulse mode and other modulation
Electrical Fast Transient / Burst	IEC61000-4-4	Level 3 Criteria A ¹⁾ :2kV
Surge	IEC61000-4-5	Level 3 Criteria A ¹⁾ Common Mode ³⁾ : 2kV Differential Mode ⁴⁾ : 1kV
Conducted	IEC61000-4-6	Level 2 Criteria A ¹⁾ 150kHz-80MHz, 3Vrms, 6Vrms at ISM bands and Amateur radio bands
Power Frequency Magnetic Fields	IEC61000-4-8	Criteria A ¹⁾ Magnetic field strength 30A/m
Voltage Dips	IEC61000-4-11	Criteria A ¹⁾ 0% U _T , 0.5 cycle (10ms), 0°/45°/90°/135°/180°/225°/270°/315°/360° Criteria A ¹⁾ 0% U _T , 1 cycle (20ms), 0° Criteria B ²⁾ 70% U _T , 25 cycle (500ms), 0° Criteria B ²⁾ 0% U _T , 250 cycle (5000ms), 0°

1) Criteria A: Normal performance within the specification limits

2) Criteria B: Output out of regulation, or shuts down during test. Automatically restore to normal operation after test.

3) Asymmetrical: Common mode (Line to earth)

4) Symmetrical: Differential mode (Line to line)

MDS Medical AC-DC Open Frame

400Watt / MDS-400AUS□ B

Block Diagram

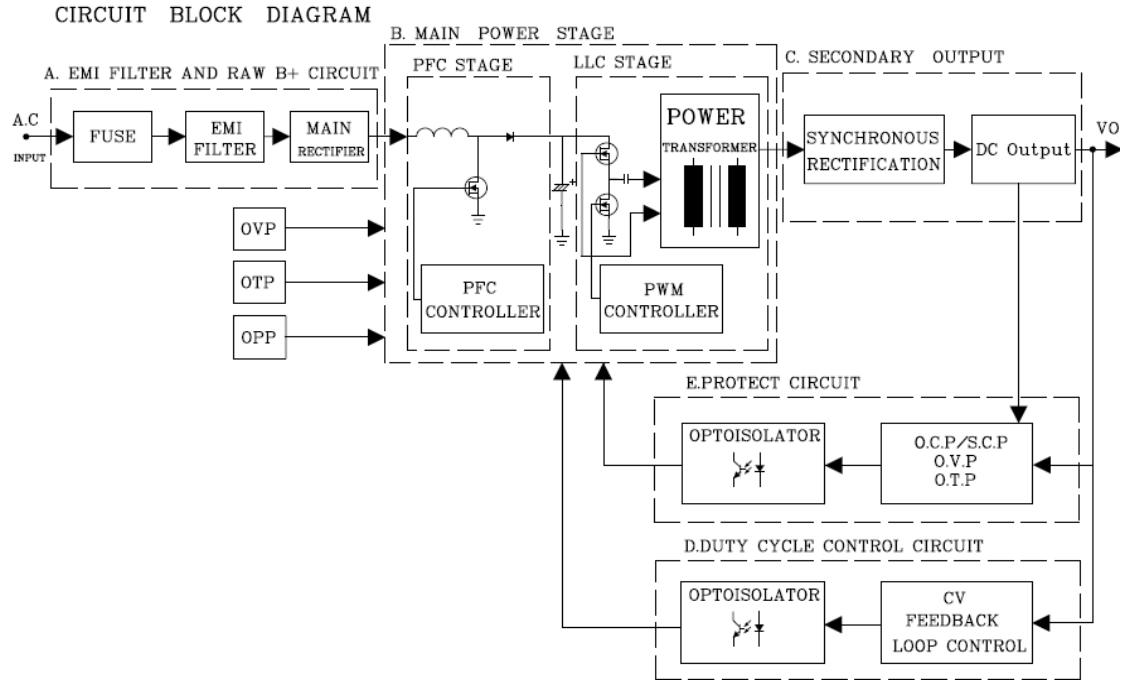

MDS Medical AC-DC Open Frame

400Watt / MDS-400AUS□ B

Dimensions (For MDS-400AUS19/24 B)

L x W x D: 97.0 x 198.0 x 41.5 mm (3.82x7.80x1.63 in)

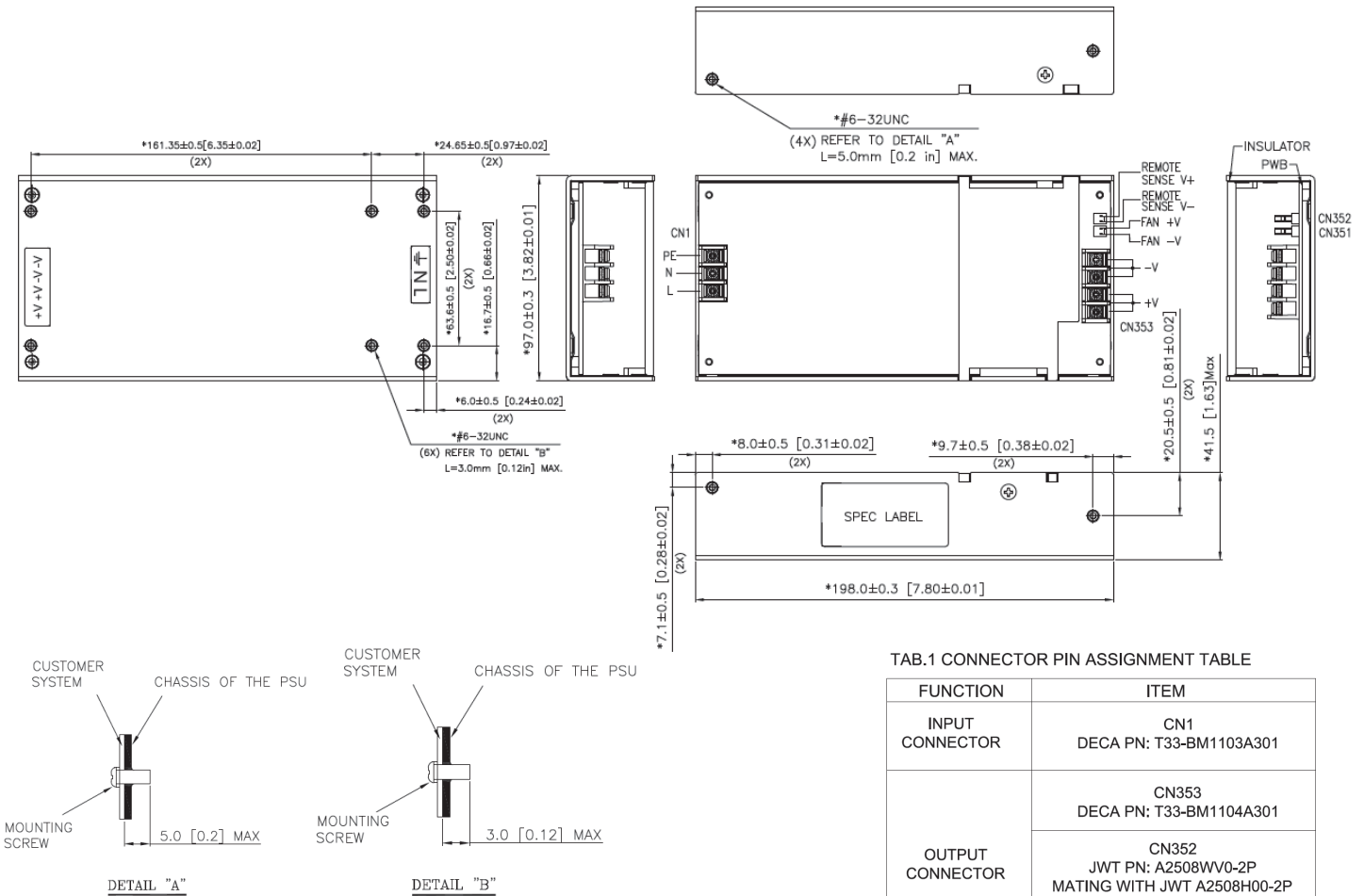

TAB.1 CONNECTOR PIN ASSIGNMENT TABLE

FUNCTION	ITEM
INPUT CONNECTOR	CN1 DECA PN: T33-BM1103A301
	CN353 DECA PN: T33-BM1104A301
OUTPUT CONNECTOR	CN352 JWT PN: A2508WV0-2P MATING WITH JWT A2508H00-2P
	CN351 JWT PN: A2508WV0-2P MATING WITH JWT A2508H00-2P

Notes

- Dimensions are in mm (inches)
- There are two locations where assembled power supply is connected to the customer's product
 - Bottom mounting, use (6X) #6-32 UNC screws to affix assembled power supply to product's enclosure. Thread must be withstand 12Kgf-cm (10.4lb-in) min. Maximum allowed screw penetration is 3.0mm (0.12 inch).
 - Side mounting, use (4X) #6-32 UNC screws to affix one side of assembled power supply to the product's enclosure. Thread must be withstand 12Kgf-cm (10.4lb-in) min. Maximum allowed screw penetration is 5.0mm (0.2 inch)

MDS Medical AC-DC Open Frame

400Watt / MDS-400AUS□ B

Dimensions (For MDS-400AUS30 B)

L x W x D: 97.0 x 198.0 x 41.5 mm (3.82x7.80x1.63 in)

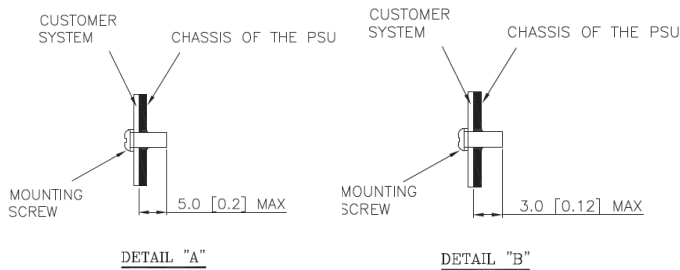
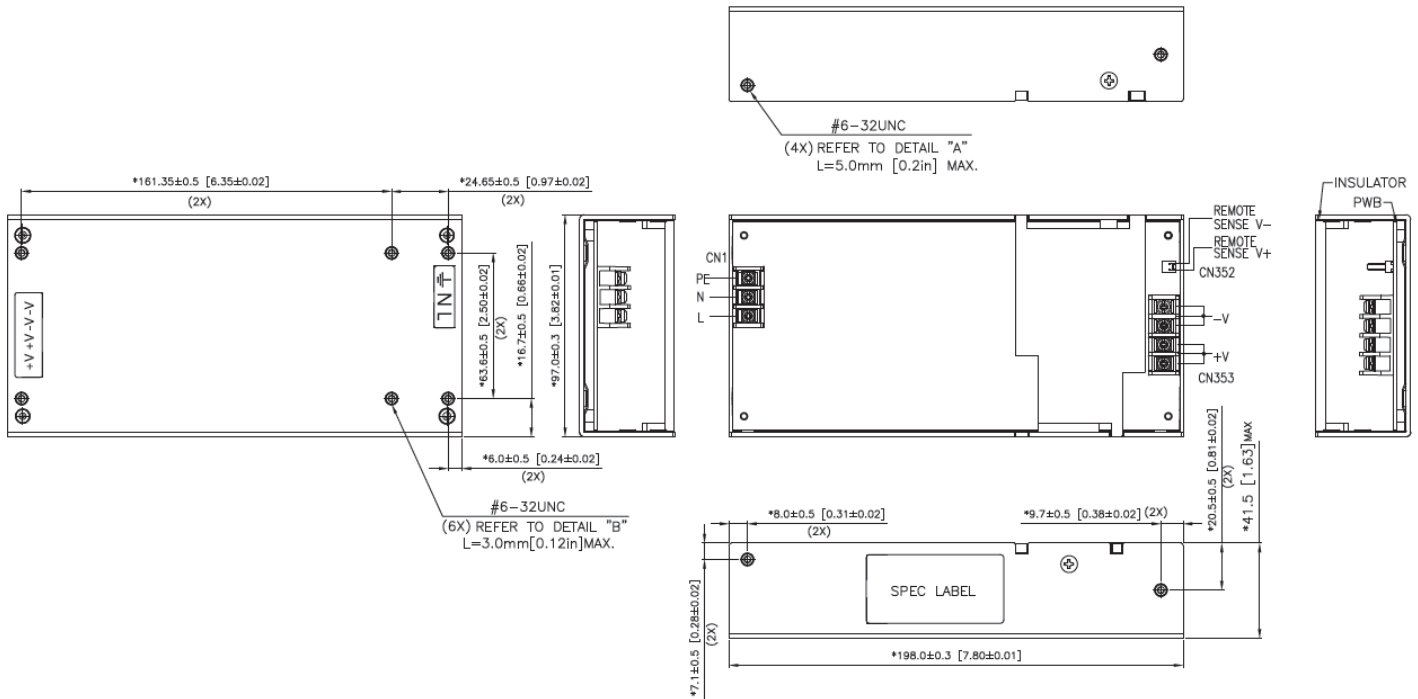

TAB.1 CONNECTOR PIN ASSIGNMENT TABLE

FUNCTION	ITEM
INPUT CONNECTOR	CN1 DECA PN: T33-BM1103A301
	CN353 DECA PN: T33-BM1104A301
OUTPUT CONNECTOR	CN352 JWT PN: A2543WV0-2P MATING WITH JWT PN:A2543H00-2P

- Dimensions are in mm (inches)
- There are two locations where assembled power supply is connected to the customer's product
 - Bottom mounting, use (6X) #6-32 UNC screws to affix assembled power supply to product's enclosure. Thread must be withstand 12Kgf-cm (10.4lb-in) min. Maximum allowed screw penetration is 3.0mm (0.12 inch).
 - Side mounting, use (4X) #6-32 UNC screws to affix one side of assembled power supply to the product's enclosure. Thread must be withstand 12Kgf-cm (10.4lb-in) min. Maximum allowed screw penetration is 5.0mm (0.2 inch)

MDS Medical AC-DC Open Frame

400Watt / MDS-400AUS□ B

De-rating Curve

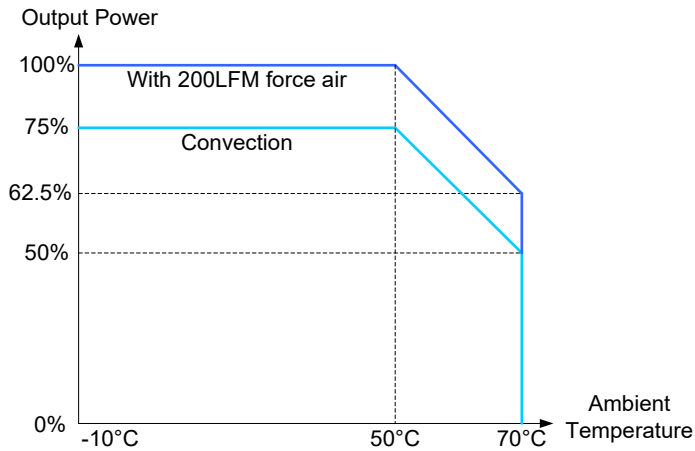

Fig.3-1 MDS-400AUS19&24V de-rating curve

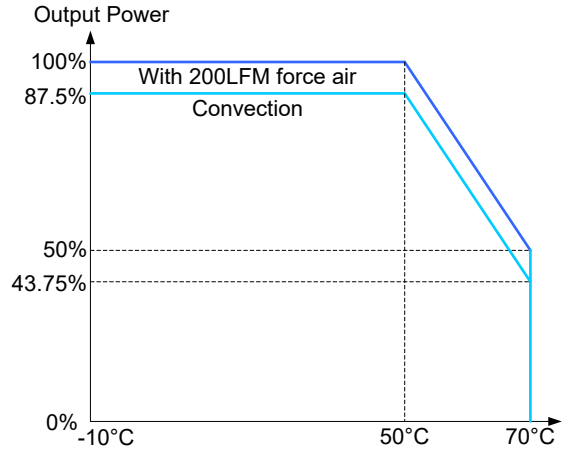

Fig.3-2 MDS-400AUS30V de-rating curve

Functions

Start-up Time

The time required for the output voltage (V_o) to reach 90% of its set value, after the input AC voltage is applied.

Rise Time

The time required for the output voltage (V_o) to change from 10% to 90% of its steady state value.

Hold-up Time

Hold up time is the time when the AC input collapses and output voltage retains regulation for a certain period of time. The time required for the output to reach 95% of its set value, after the input voltage is removed.

■ Graph illustrating the Start-up Time, Rise Time, and Hold-up Time

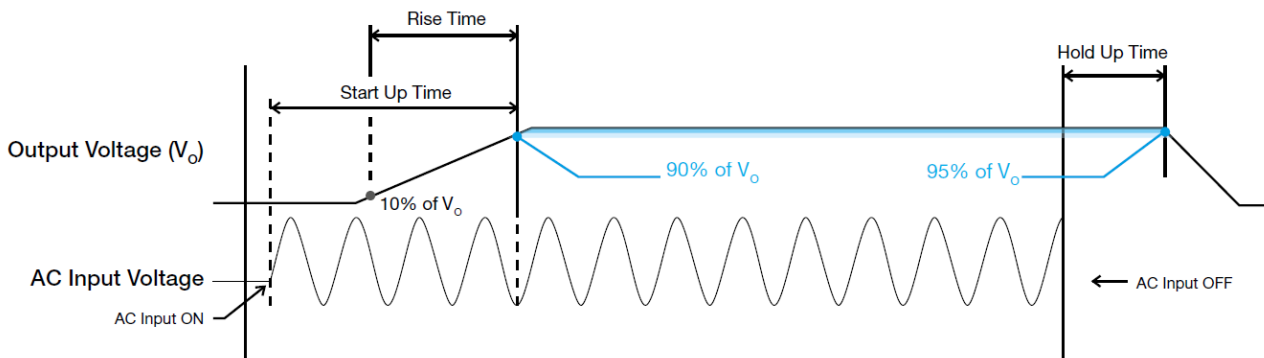

MDS Medical AC-DC Open Frame

400Watt / MDS-400AUS□ B

Dynamic Response

The power supply output voltage will remain within $\pm 3\%$ of its steady state value, when subjected to a dynamic load change from 50 to 100% of its rated current.

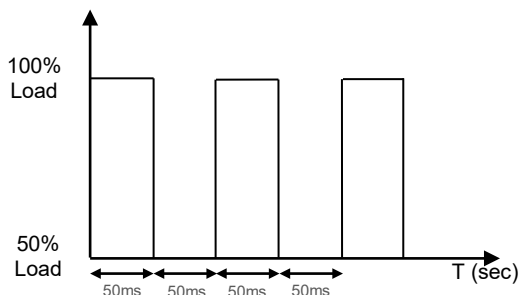

Inrush Current

Inrush current is the input current that occurs when the input voltage is first applied. For AC input voltages, the maximum peak value of inrush current will occur during the first half cycle of the applied AC voltage. This peak value decreases exponentially during subsequent cycles of AC voltage.

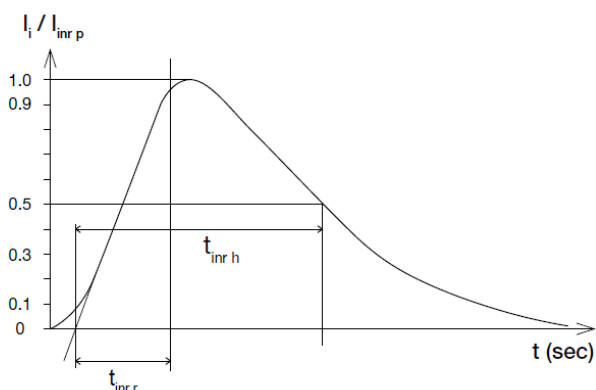

Overvoltage Protection

The power supply's overvoltage circuit will be activated when its internal feedback circuit fails. The output voltage shall not exceed its specifications defined on Page 4 under "Protections". Power supply will latch off, and require removal/re-application of input AC voltage in order to restart.

Short Circuit Protection

The power supply's output OLP/OCP function also provides protection against short circuits. When a short circuit is applied, the output current will operate in "Hiccup mode", as shown in the illustration in the OLP/OCP section on this page. The power supply will return to normal operation after the short circuit is removed.

Overload & Over current Protections

The power supply's Overload (OLP) and Over current (OCP) Protections will be activated when output current is between 110% and 130% of I_o (Max load). Upon such an occurrence, V_o will start to drop. Once the power supply has reached its maximum power limit, the protection will be activated. and the power supply will go into "Hiccup mode" (Auto-Recovery). The power supply will recover once the fault condition causing the OLP and OCP is removed and I_o is back within the specified limit.

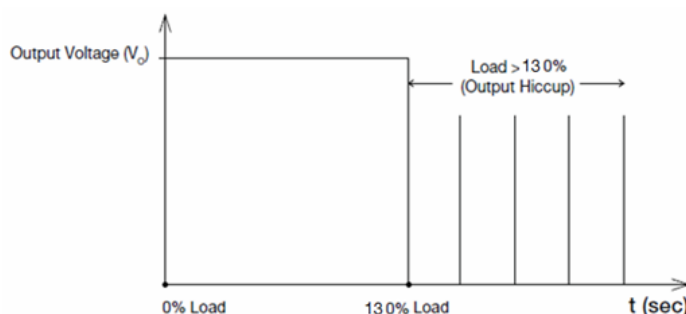

Additionally, if the I_o is $< 130\%$ but $> 110\%$ for a prolong period of time (depending on the load), the Over Temperature Protection (OTP) will be activated due to high temperature on critical components. The power supply will then go into hiccup mode until the fault is removed; and, the input voltage is removed, then reapplied.

Over Temperature Protection

As mentioned above, the power supply also has Over Temperature Protection (OTP). This is activated when the overload condition persists for an extended duration and the output current is below the overload trigger point but $> 100\%$ load. In the event of a higher operating condition at 100% load, the power supply will run into OTP when the surrounding air temperature is higher than the operating temperature. When activated, the output voltage will go into hiccup mode (latch off mode for MDS-400AUS19 B) until the input voltage is removed; then, reapplied, and the surrounding air temperature drops to its normal operating temperature.

MDS Medical AC-DC Open Frame

400Watt / MDS-400AUS□ B

Certificate



Delta has been certified as meeting the requirement of ISO 13485: 2003 and EN ISO 13485:2012 for the design and manufacture of switching power supply and adaptor for medical device.



In addition to a UL Total Certification Program (TCP) approved client laboratory for IEC 62368-1. Delta also has participated UL Client Test Data Program (CDTP) for IEC 60601

Attention

Delta provides all information in the datasheets on an "AS IS" basis and does not offer any kind of warranty through the information for using the product. In the event of any discrepancy between the information in the catalog and datasheets, the datasheets shall prevail, (please refer to www.DeltaPSU.com for the latest datasheets information). Delta shall have no liability of indemnification for any claim or action arising from any error for the provided information in the datasheets. Customer shall take its responsibility for evaluation of using the product before placing an order with Delta.

Delta reserves the right to make changes to the information described in the datasheets without notice.